



INDEX MODÈLES | MODELS

ALSACE.....	12	EPIC.....	34	PIXEL.....	50
ALTA.....	46	EXECUTIVE FRAME.....	65	PLASMA.....	14
AMADEUS.....	16	EXECUTIVE PANEL.....	64	QUATTRO.....	48
AZUR.....	47	FRAGRANCE.....	4	QUENOUILLE.....	58
BEATRICE.....	30	FUSION.....	22	RENOIR.....	54
BLINK BLINDS.....	62	GABRIELLA.....	8	RODIN.....	49
CADENCE.....	19	GRAIN.....	26	SATINÉ.....	26, 27, 28
CADRE EXÉCUTIF.....	65	HARMONIE.....	18	SCREEN.....	26
CADRE URBAIN.....	65	INFINITY.....	53	SÉVY.....	23
CANVA.....	29	INTEGRATED BLINDS.....	63	SHIRAZ.....	10
CBG.....	6	KARMA.....	28	STORE INTÉGRÉ.....	63
CHINOOK.....	61	LATÉRAUX SUR MESURE.....	60	STORES BLINK.....	62
CLIMATEC.....	72	LINEA.....	27, 28	TENDANCE.....	38
CORDUROY.....	29	MATHEUS.....	36	TIA.....	42
CRÉATION SELECT.....	66	MIA.....	51	TUSCANY.....	52
CUBISTE.....	32	MOULURES DYNASTIE.....	64	URBAN FRAME.....	65
CUSTOM SIDELITE.....	60	NOVOBOIS.....	68	URBAN PANEL.....	24, 29
DYNASTIE MOLDING.....	64	PANNEAU EXÉCUTIF.....	64	VENUS.....	56
EDGE.....	74	PANNEAU URBAIN.....	24, 29	VERSAILLES.....	40
ENDRICK.....	20	PIANO.....	21	WHISTLER.....	44

NOTES | NOTES

Les photos présentées peuvent avoir de légères différences de couleurs et de textures avec le produit réel. Verre Select se réserve le droit de modifier la composition des produits illustrés dans la brochure.

The pictures might have some small differences of colors and textures with the real product. Verre Select reserves the right to modify the composition of the products shown in this brochure.

VERRE LOW-E + GAZ ARGON : Tous nos produits sont fabriqués selon un procédé de fabrication utilisant un verre à haut rendement énergétique, grâce à son revêtement invisible bloquant le passage de l'énergie calorifique, additionné d'un gaz Argon, moins conducteur que l'air, inséré à l'intérieur de l'unité scellée.

LOW-E GLASS + ARGON GAS : *All our products are made with an invisible coating that blocks heat flow and is blended inside the sealed unit with Argon gas, which is less conductive than the ambient air.*



PAGE COUVERTURE | COVER PAGE:
GAB108NSE+-AR

NOTRE GARANTIE | OUR WARRANTY

Tous les produits de verre décoratif de Verre Select sont vendus avec une garantie limitée de 10 ans. Pour notre garantie complète consultez le www.verreselect.com

All decorative glass products sold by Verre Select come with a limited 10 years warranty. For complete warranty please go to www.verreselect.com

Les produits Verre Select sont utilisés dans la fabrication de portes et fenêtres homologuées Energy Star.

Verre Select products are used in the manufacture of Energy Star - approved doors and windows.



Pour plus d'information www.verreselect.com
For more information www.verreselect.com

CONTEMPORAINE | CONTEMPORARY

Les lignes épurées sont un élément clé de notre collection contemporaine qui exsude un charisme moderne. Nous produisons ces vitraux à partir de nos nombreux verres décoratifs qui sauront mettre en valeur votre demeure tendance et en faire le sujet de conversation du quartier!

Clean, sleek, straight lines are key elements in our contemporary collection pieces. They exude a truly modern charisma. We produce these doorlites using our many unique patterned and textured glasses which enhance the trendy looks, and will make your entrance system the talk of the neighbourhood!

PAGE 4



CLASSIQUE | CLASSIC

Nos classiques sont des valeurs sûres et sont l'essentiel de notre offre de produits. Ces modèles sauront mettre en valeur et agrémenter tout type de demeure pour de nombreuses années à venir. Notre sélection variée vous permet un choix sûr à tout coup.

Our "Classics" really are just that, and are the centrepieces of our offering. These popular yet more conservative designs work on any home, and will dramatically improve your curb appeal instantly. You have a lot of choices but can never go wrong with these.....

PAGE 30



TRADITIONNELLE | TRADITIONAL

Le vieux charme traditionnel est bien présent dans cette collection. Plusieurs propriétaires désirent garder le charme d'antan de leur demeure et nous serons toujours présents pour les aider dans cette quête. Nous ne pourrions nous opposer à un style qui a survécu à des générations.

Old world charm is alive and well, and evident in our Traditional collection. Many homeowners still prefer these designs which is why they remain in our offering year after year. You can't argue with success, in achieving a timeless and beautiful entranceway...

PAGE 51

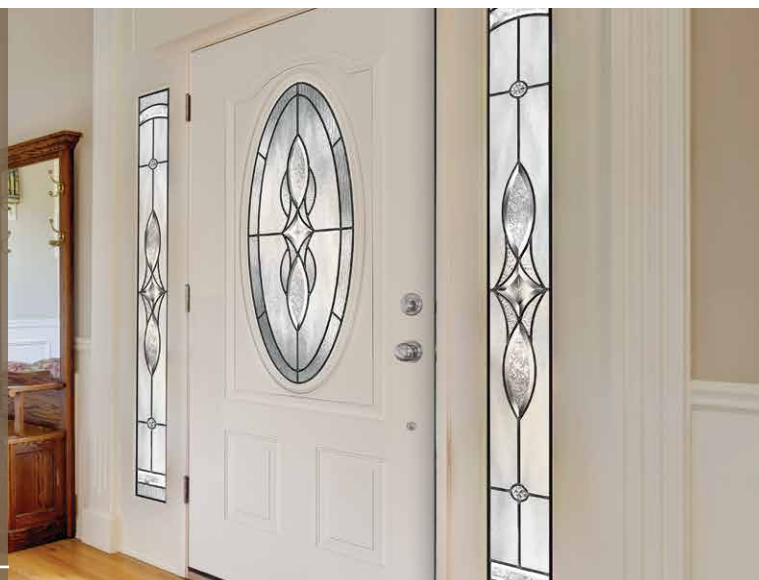

NOUVEAU
NEW



Verre Sablé 1
Sandblast glass

Zone claire 2
Clear zone

INTIMITÉ | INTIMACY

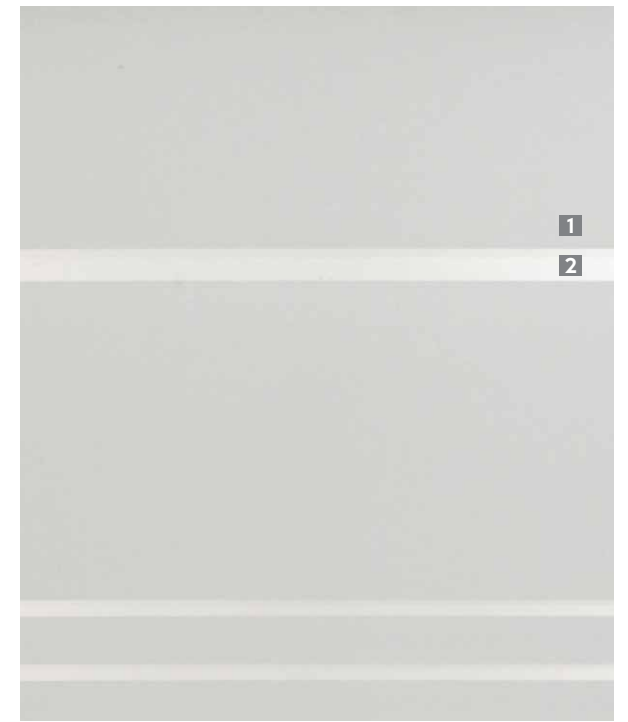

23" X 18" \$
FRA090E+ (1X)



23" X 18" \$
FRA090E+ (3X)



23" X 49" \$
FRA104E+



9" X 49" \$
FRA105E+



23" X 65" \$
FRA108E+



8" X 65" \$
FRA107E+

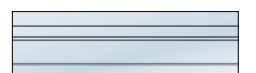

NOTE: IMPOSTES ET LATÉRAUX DISPONIBLES | TRANSOMS AND SIDELITES AVAILABLE

NOUVEAU
NEW



Zone Claire 1" 1
1" Clear Glass

Verre Sablé 2
Sandblast glass

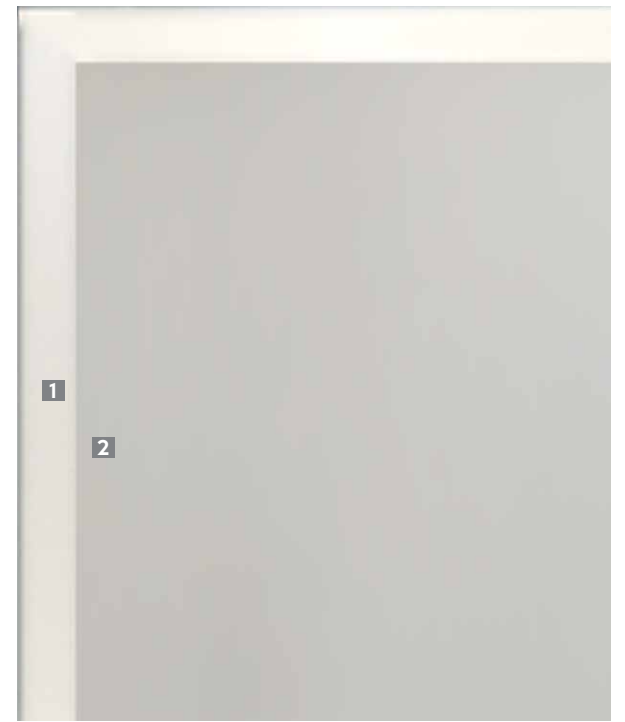

23" X 18" \$
CBG090E+ (1X)



23" X 49" \$
CBG104E+



9" X 49" \$
CBG105E+



23" X 65" \$
CBG108E+



8" X 65" \$
CBG107E+



10^{"15/16} X 76^{"11/16} \$
CBG1076E+



NOTE: IMPOSTES ET LATÉRAUX DISPONIBLES | TRANSOMS AND SIDELITES AVAILABLE

NOUVEAU
NEW



- Verre Clair **1**
Clear Glass
- Canva **2**
- Screen **3**

INTIMITÉ | INTIMACY

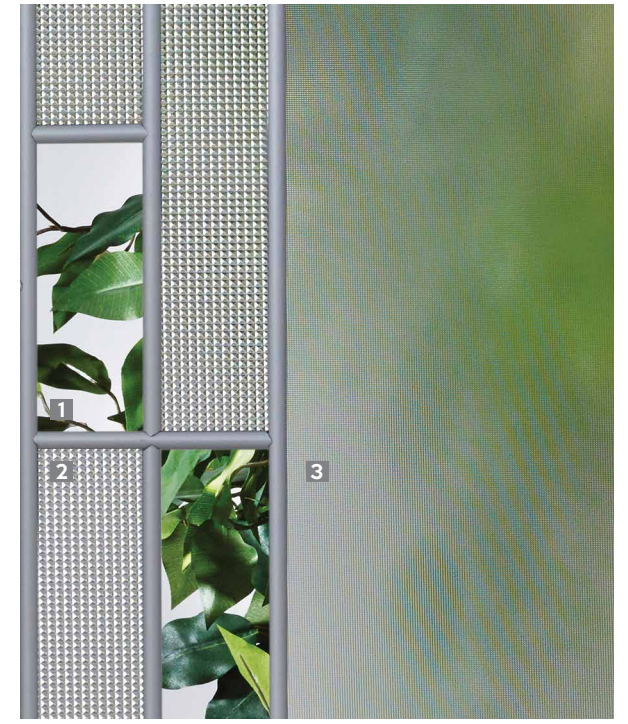

FINI STANDARD | STANDARD FINISH

NOTE: Autres finis disponibles | Other available finishes

NS-AR Non-Soudé Argent Satiné
Non-Welded Silver



23" X 49" \$
GAB104NSE+AR



9" X 49" \$
GAB105NSE+AR



23" X 65" \$
GAB108NSE+AR



8" X 65" \$
GAB107NSE+AR

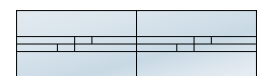

NOTE: IMPOSTES ET LATÉRAUX DISPONIBLES | TRANSOMS AND SIDELITES AVAILABLE

NOUVEAU
NEW



Morocco Clair 1
Clear Morocco

Corduroy 2

Verre Clair 3
Clear Glass

Linea 4

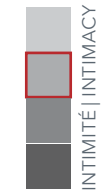

FINI STANDARD | STANDARD FINISH

NOTE: Autres finis disponibles | Other available finishes

NS-AR Non-Soudé Argent Satiné
Non-Welded Silver



23" X 49" \$
SHI104NSE+-AR



9" X 49"
SHI105NSE+-AR



23" X 65" \$
SHI108NSE+-AR



8" X 65"
SHI107NSE+-AR



NOTE: IMPOSTES ET LATÉRAUX DISPONIBLES | TRANSOMS AND SIDELITES AVAILABLE

NOUVEAU
NEW



"Resin Art" Noir sur verre Satiné 1
Black "Resin Art" on Acid Etch

Zone claire 2
Clear zone

Satiné 3
Acid etch

INTIMITÉ | INTIMACY



NOUVEAU PROCÉDÉ DE FABRICATION
NEW MANUFACTURING PROCESS

— "Resin Art" Noir
Black "Resin Art"



23" X 18" \$
ALS090E+ (1X)



23" X 18" \$\$\$
ALS090E+ (3X)



23" X 49" \$
ALS104E+



9" X 49" \$\$\$
ALS105E+



23" X 65" \$\$
ALS108E+



8" X 65" \$\$\$
ALS107E+

NOUVEAU
NEW



Satiné 1
Acid etch

"Resin Art" Clair sur verre Satiné 2
Clear "Resin Art" on Acid Etch



NOUVEAU PROCÉDÉ DE FABRICATION
NEW MANUFACTURING PROCESS

"Resin Art" Clair
Clear "Resin Art"



23" X 18" \$
PLA090E+ (1X)



23" X 18" \$\$\$
PLA090E+ (3X)



23" X 49" \$
PLA104E+



9" X 49" \$
PLA105E+



23" X 65" \$\$
PLA108E+



8" X 65" \$
PLA107E+



- Screen **1**
- Screen biseauté **2**
Beveled Screen
- Linea **3**
- Kasumi **4**

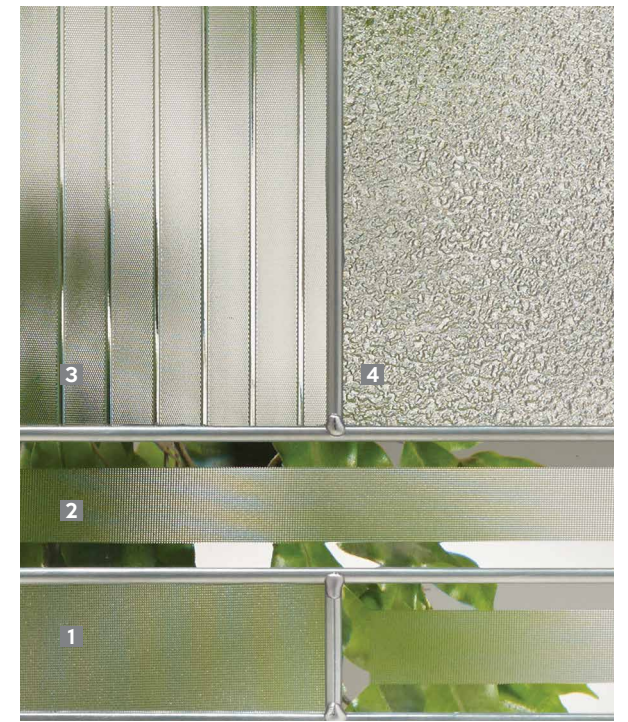

FINI STANDARD | STANDARD FINISH
NOTE: Autres finis disponibles | Other available finishes

 PL Plomb soudé
Welded Lead



23" X 49" \$
AMA104E+ - PL



9" X 49" \$
AMA105E+ - PL



23" X 65" \$\$
AMA108E+ - PL



8" X 65" \$
AMA107E+ - PL

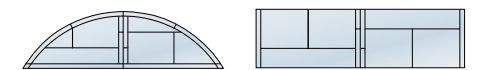

NOTE: IMPOSTES ET LATÉRAUX DISPONIBLES | TRANSOMS AND SIDELITES AVAILABLE



CARRELAGE RECTANGULAIRE 2" INTÉGRÉ
RECTANGULAR INTEGRATED 2" GRILLS

Intérieur blanc
Interior white

Extérieur noir
Exterior black

NOUVEAU
NEW



CARRELAGE RECTANGULAIRE 2" INTÉGRÉ
RECTANGULAR INTEGRATED 2" GRILLS

Intérieur blanc
Interior white

Extérieur noir
Exterior black

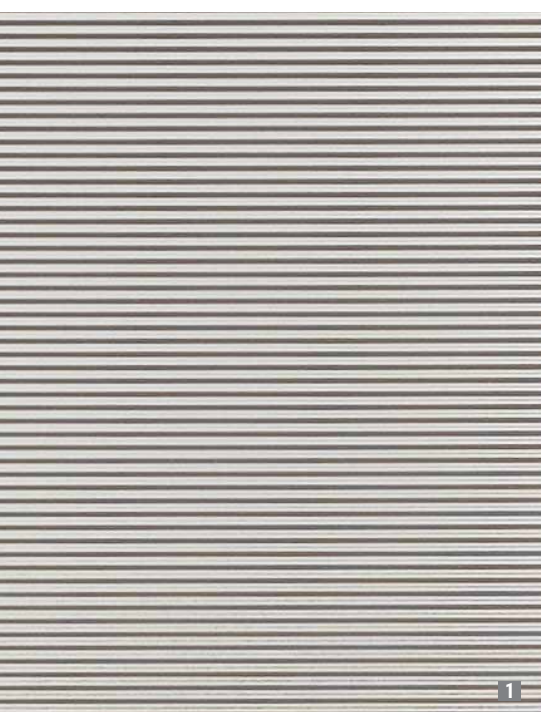

1 Corduroy



COULEUR DU CARRELAGE 2" | 2" GRILL COLOR



Côté extérieur NOIR
Exterior side BLACK

Côté intérieur BLANC
Interior side WHITE



COULEUR DU CARRELAGE 2" | 2" GRILL COLOR



Côté extérieur NOIR
Exterior side BLACK

Côté intérieur BLANC
Interior side WHITE

CHOIX DE VERRE | GLASS CHOICE

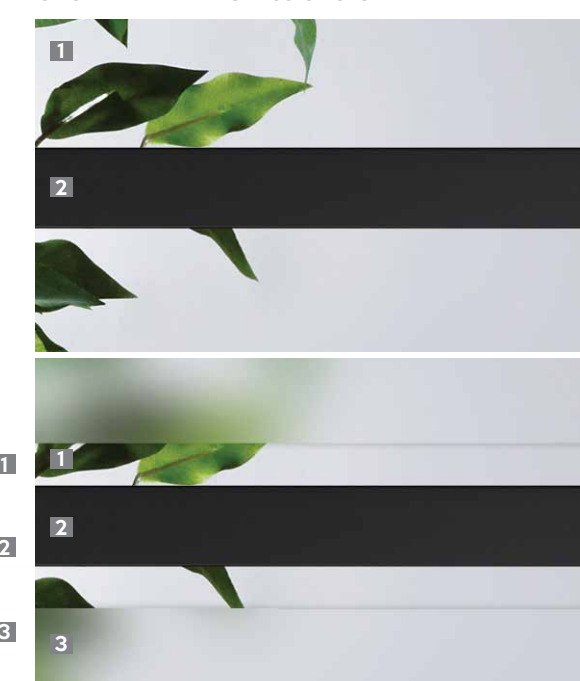

Clair | Clear 1

Carrelage 2" | 2" Grill 2

Verre Sablé | Sandblast glass 3

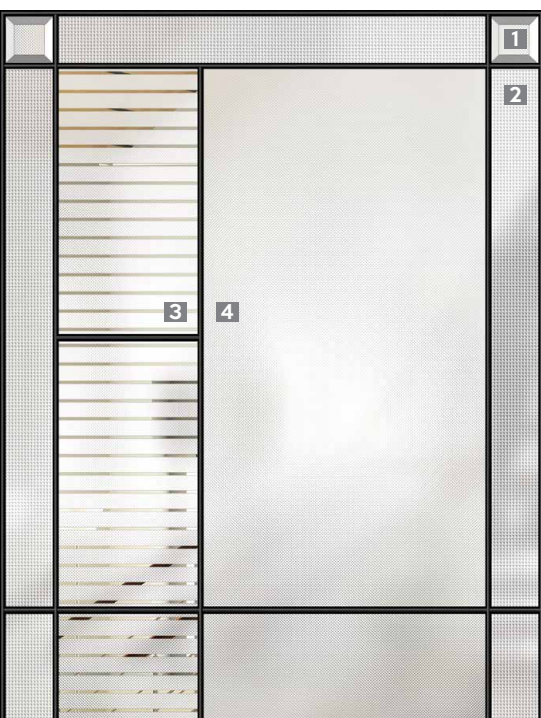
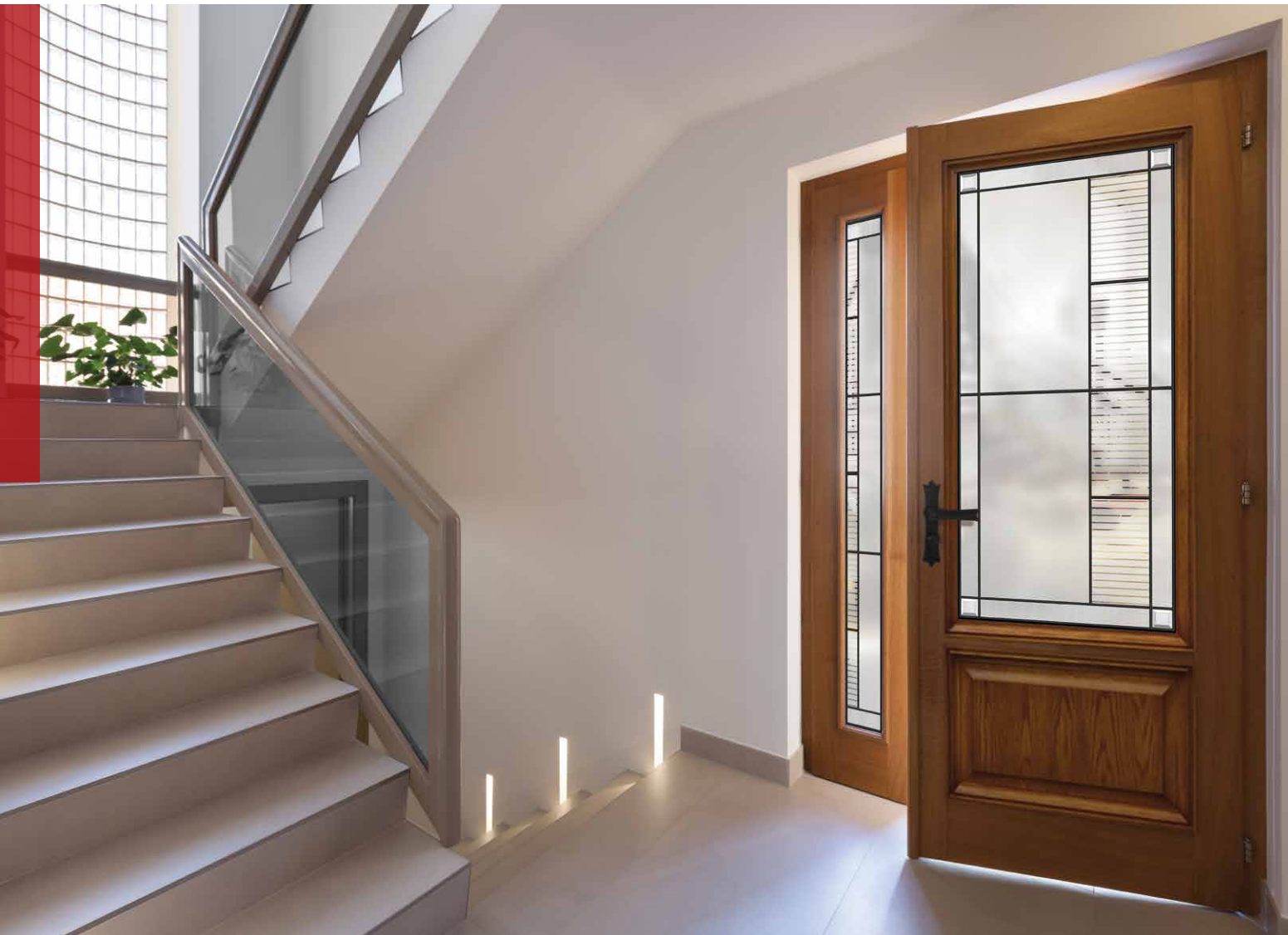

- 1 Screen biseauté
Beveled Screen
- 2 Canva
- 3 Linea
- 4 Screen

INTIMITÉ | INTIMACY



FINI STANDARD | STANDARD FINISH

NOTE: Autres finis disponibles | Other available finishes

NS-NO Non-soudé Noir | Non-Welded Black



Métal découpé au laser
Laser cut metal

CHOIX DE 3 VERRES
3 GLASS CHOICES

- Kasumi 1
- Satiné
Acid Etch 2
- Clair
Clear 3

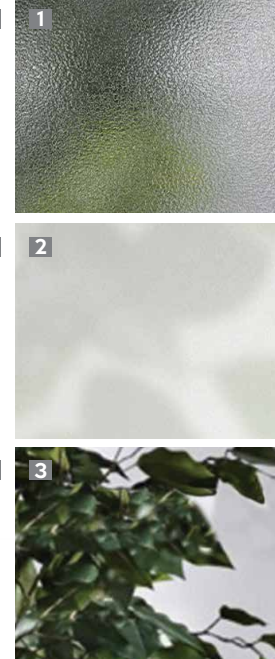

NOUVEAU
NEW

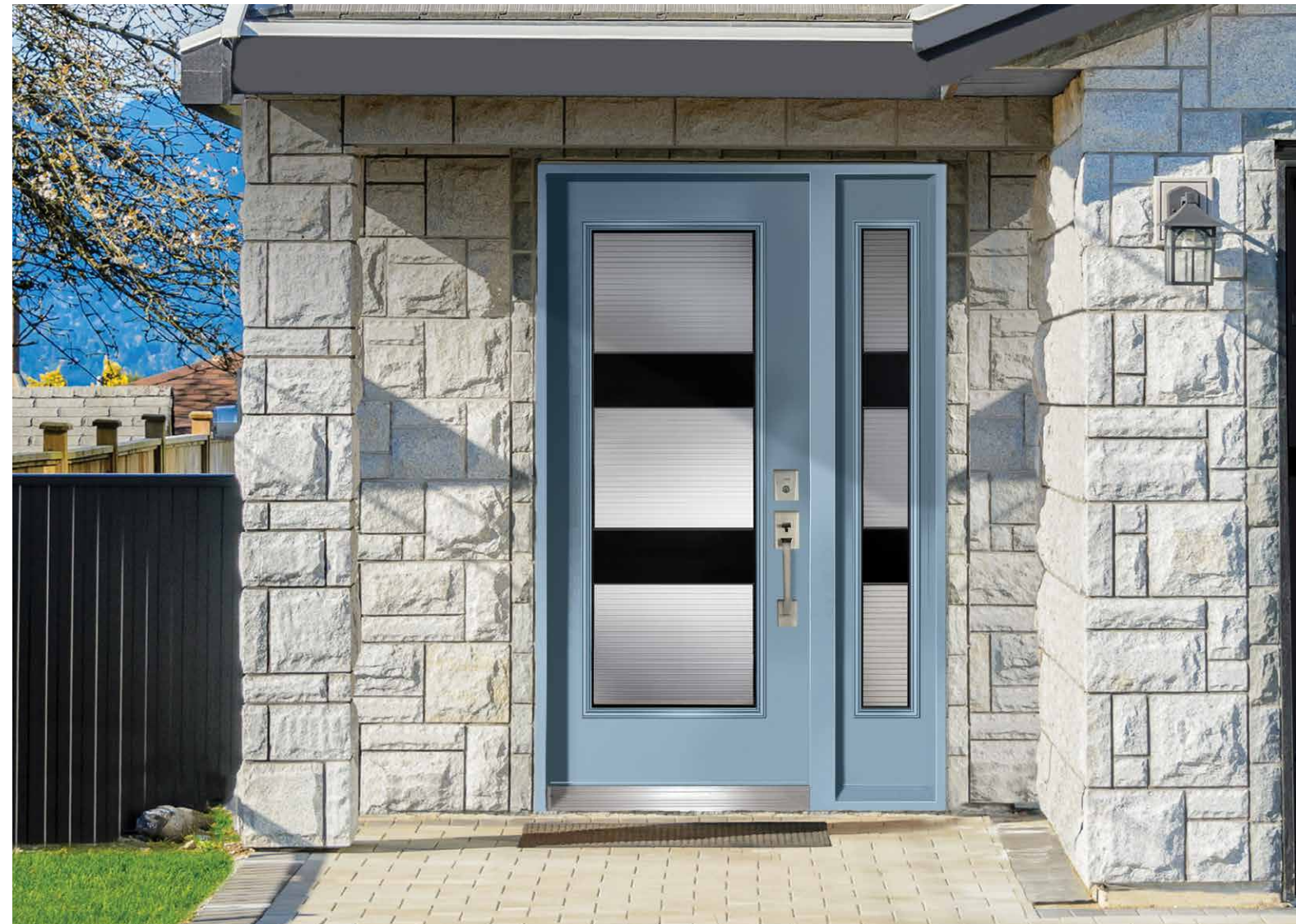

CHOIX DE VERRE | GLASS CHOICE



- 1 Clair | Clear
- 2 Satiné | Acid Etch



23" X 18" \$ FUS090-CLRE+ 23" X 18" \$ FUS090-SATE+

Verre fusionné | Fused Glass



23" X 65" \$\$ SEV108NSE+-NO 8" X 65" SEV107NSE+-NO

FINI STANDARD | STANDARD FINISH

NOTE: Autres finis disponibles | Other available finishes

NS-NO Non-soudé noir | Non-Welded Black

- Linea 1
- Tige Noire
Black Caming 2
- Noir Opaque
Opaque Black 3

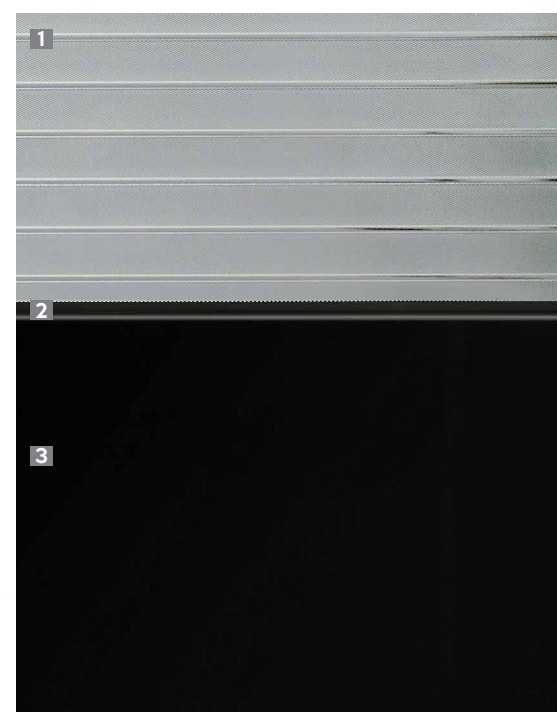

INTIMITÉ | INTIMACY

PANNEAU URBAIN | URBAN PANEL



**NOUVEAU
NEW**

**PORTES SURDIMENSIONNÉES | DECORATIVE
DÉCORATIVES | OVERSIZED DOORS**

L'effet "WOW"!
The "WOW" factor!



23" X 65"

23" X 13"



PANNEAUX STANDARDS DISPONIBLES | AVAILABLE STANDARD PANELS:





SAT098E+ (4X) \$\$\$



SCR098E+ (4X) \$\$\$

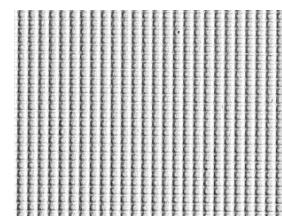

SAT090E+ (3X) \$

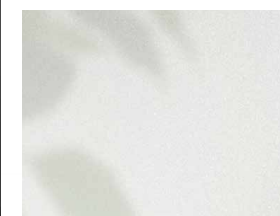

SAT757E+ \$\$

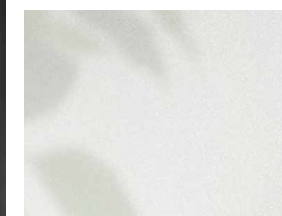

Note: Le sens des lignes peut varier pour certains verres.
 Note: The line's direction may vary for some glasses.

Note: Le sens des lignes peut varier pour certains verres.
 Note: The line's direction may vary for some glasses.

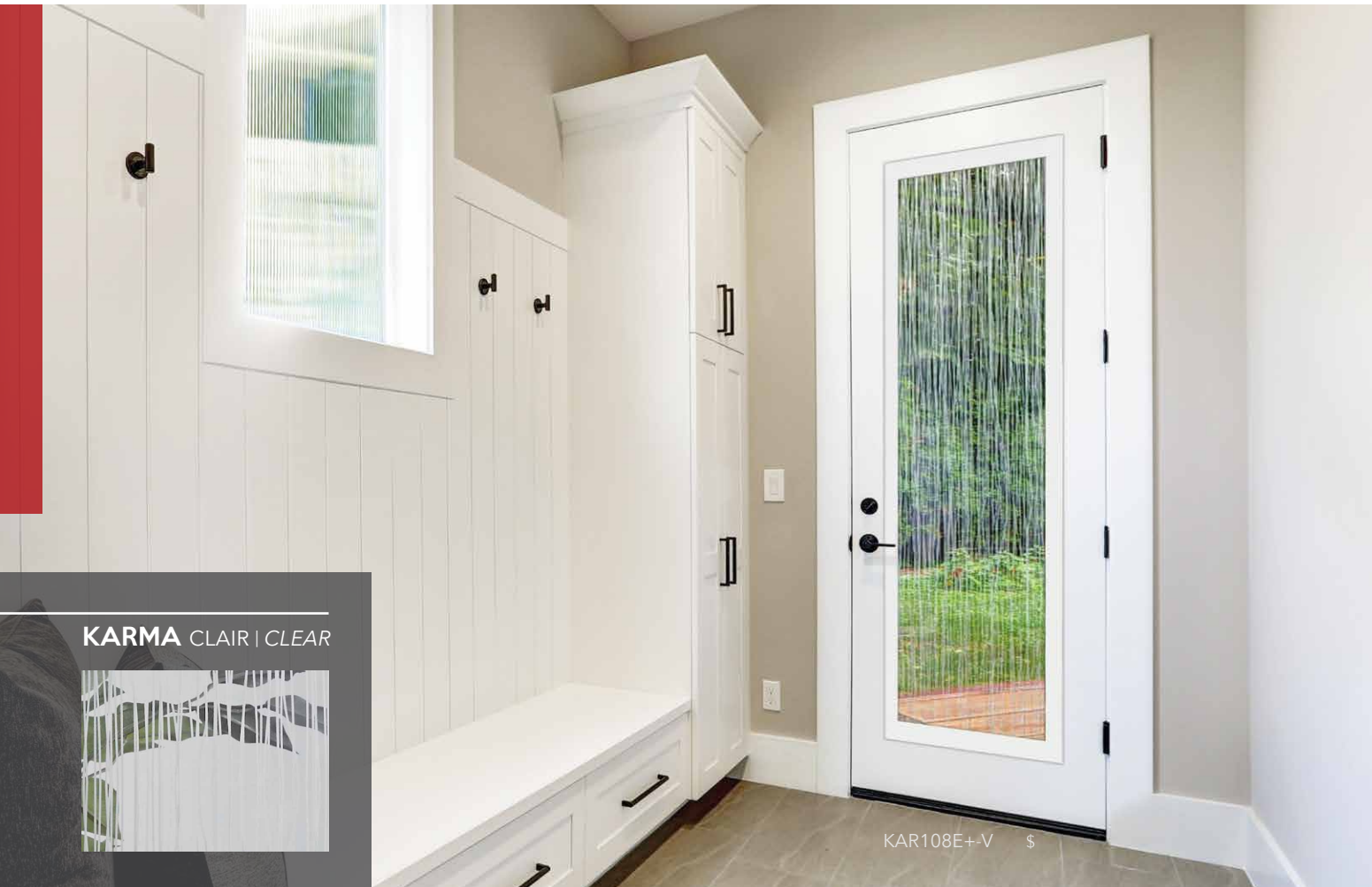

KARMA CLAIR | CLEAR



KAR108E+V \$



CORDUROY



COR067E+H (5X) COR068E+H (5X) \$\$\$



LINEA

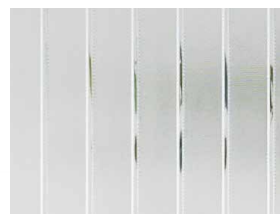

LIN108E+V \$



KARMA OPAQUE

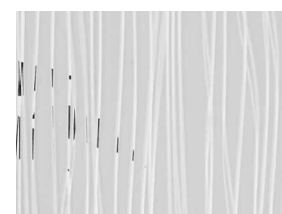

KAR0108E+V \$



CANVA

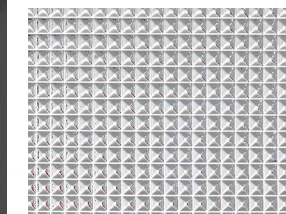

CAN094E+ (5X) \$\$\$\$



PANNEAU URBAIN

Verre clair
Clear glass



068CE+ (1X)
PURB068-UA (4X) \$\$\$



Niagara 1

Screen 2



FINI STANDARD | STANDARD FINISH

NOTE: Autres finis disponibles | Other available finishes

■ NS-AR Non-Soudé Argent Satiné
Non-Welded Silver



23" X 49" \$\$
BEA104NSE+AR



9" X 49" \$
BEA105NSE+AR



23" X 65" \$\$\$
BEA108NSE+AR



8" X 65" \$
BEA107NSE+AR

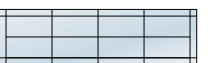

NOTE: IMPOSTES ET LATÉRAUX DISPONIBLES | TRANSOMS AND SIDELITES AVAILABLE



Screen biseauté 1
Beveled Screen

Kasumi 2

Clair biseauté 3
Beveled Clear

Morocco clair 4
Clear Morocco

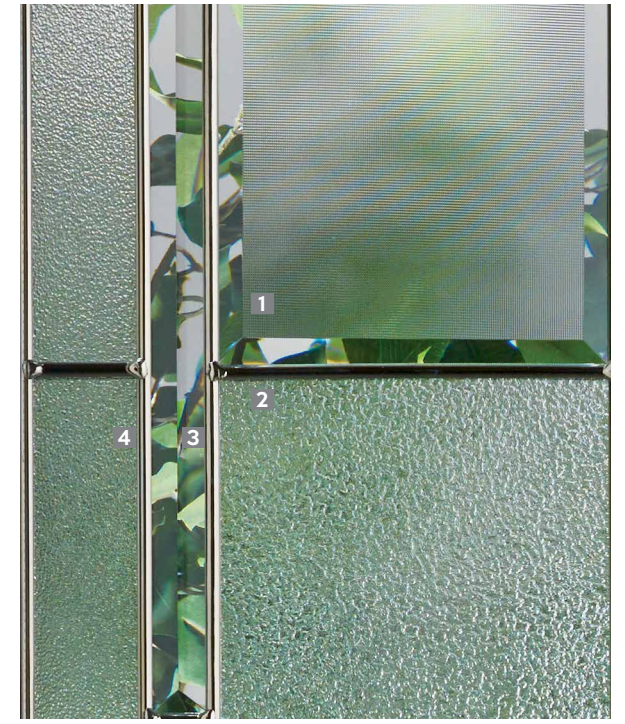

FINI STANDARD | STANDARD FINISH

NOTE: Autres finis disponibles | Other available finishes

 ON Onyx



23" X 49" \$\$
CUB104E+ON



9" X 49" \$
CUB105E+ON



21" X 65" \$\$\$\$
CUB106E+ON



23" X 65" \$\$\$\$
CUB108E+ON



8" X 65" \$
CUB107E+ON



Clair biseauté 1
Beveled clear

Granite 2
Granit

Screen biseauté 3
Beveled Screen

Grain 4



FINI STANDARD | STANDARD FINISH
NOTE: Autres finis disponibles | Other available finishes

N Plomb soudé antique
Antique Welded Lead

INTIMITÉ | INTIMACY



23" X 49" \$
EPI104E+-N



9" X 49"
EPI105E+-N



23" X 65" \$\$\$
EPI108E+-N



8" X 65"
EPI107E+-N



NOTE: IMPOSTES ET LATÉRAUX DISPONIBLES | TRANSOMS AND SIDELITES AVAILABLE





- Niagara 1
- Screen 2
- Kasumi 3
- Clair biseauté / Beveled Clear 4



FINIS STANDARDS | STANDARD FINISHES

NOTE: Autres finis disponibles | Other available finishes

-  NS-AR Non-Soudé Argent Satiné / Non-Welded Silver
-  NS-PT Non-Soudé Étain / Non-Welded Pewter



23" X 49" \$\$
MAT104NSE+PT



9" X 49" \$
MAT105NSE+PT



21" X 65" \$\$\$
MAT106NSE+PT



23" X 65" \$\$\$
MAT108NSE+PT



8" X 65" \$
MAT107NSE+PT



NOTE: IMPOSTES ET LATÉRAUX DISPONIBLES | TRANSOMS AND SIDELITES AVAILABLE



Linea **1**

Screen Biseauté **2**
Beveled Screen

Morocco Clair **3**
Clear Morocco

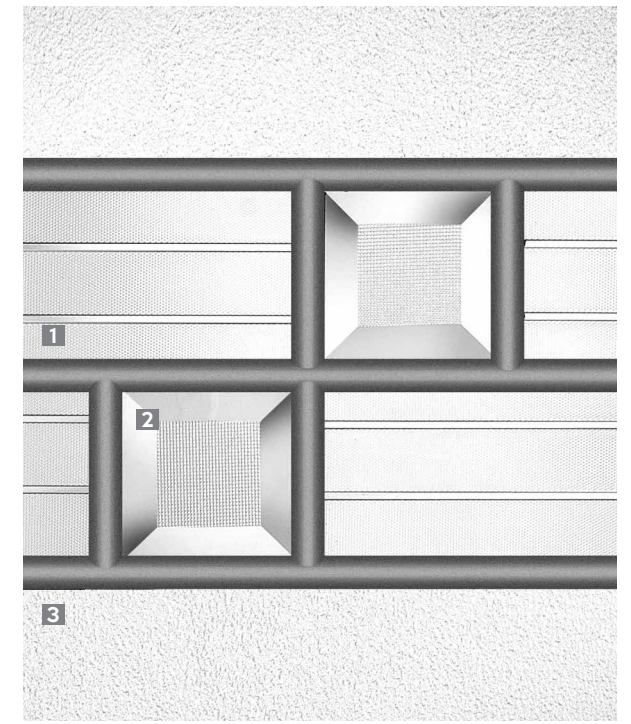

FINI STANDARD | STANDARD FINISH

NOTE: Autres finis disponibles | Other available finishes

 NS-PT Non-Soudé Étain
Non-Welded Pewter



23" X 18" \$
TEN090NSE+PT (1X)



23" X 18" \$\$\$
TEN090NSE+PT (3X)



23" X 49" \$\$
TEN104NSE+PT



9" X 49"
TEN105NSE+PT



23" X 65" \$\$\$
TEN108NSE+PT

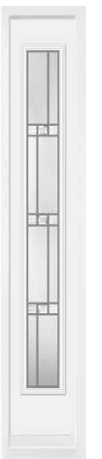

8" X 65"
TEN107NSE+PT



NOTE: IMPOSTES ET LATÉRAUX DISPONIBLES | TRANSOMS AND SIDELITES AVAILABLE

VERSAILLES



VERSAILLES **CLAIR**

Clair **1**
Clear



VERSAILLES **OBSCUR**

Kasumi **2**

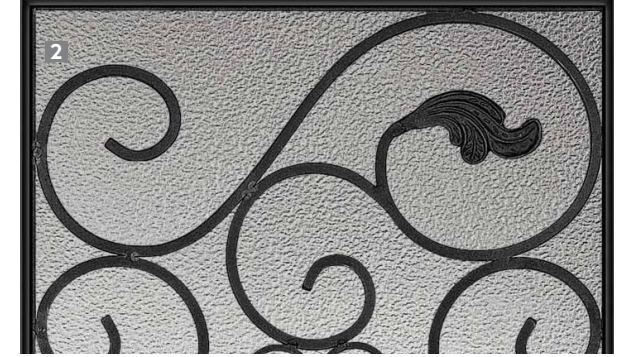

FER FORGÉ | WROUGHT IRON



VERSAILLES **OBSCUR**

VERSAILLES **CLAIR | CLEAR**



NOTE: IMPOSTES ET LATÉRAUX DISPONIBLES | TRANSOMS AND SIDELITES AVAILABLE



Tia 1

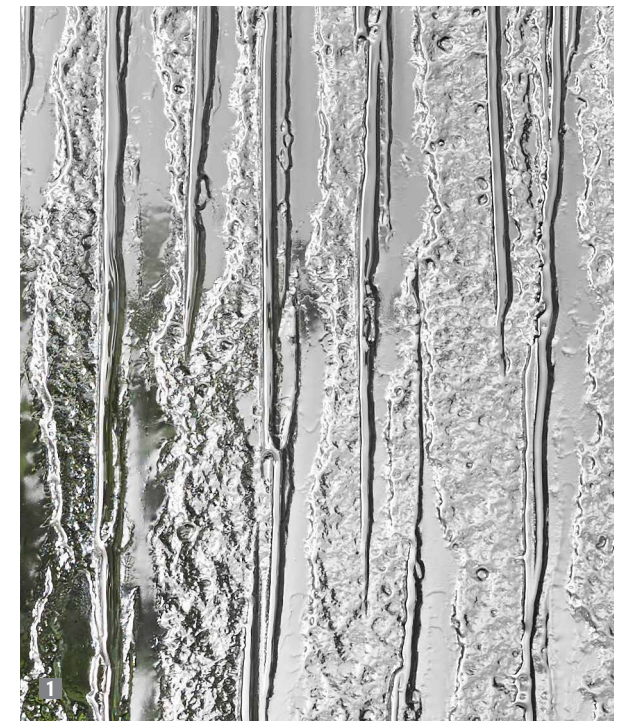

INTIMITÉ | INTIMACY

VERRE THERMOFORMÉ | CAST GLASS



23" X 18" \$\$
TIA090E+ (1X)



23" X 18" \$\$
TIA090E+ (3X)



9" X 49" \$
TIA105E+



23" X 65" \$\$\$
TIA108E+



8" X 65" \$
TIA107E+

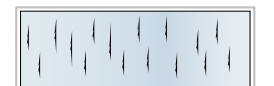
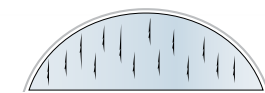

NOTE: IMPOSTES ET LATÉRAUX DISPONIBLES | TRANSOMS AND SIDELITES AVAILABLE

WHISTLER



- Kasumi 1
- Screen Biseauté
Beveled Screen 2
- Corduroy 3
- Morocco Clair
Clear Morocco 4

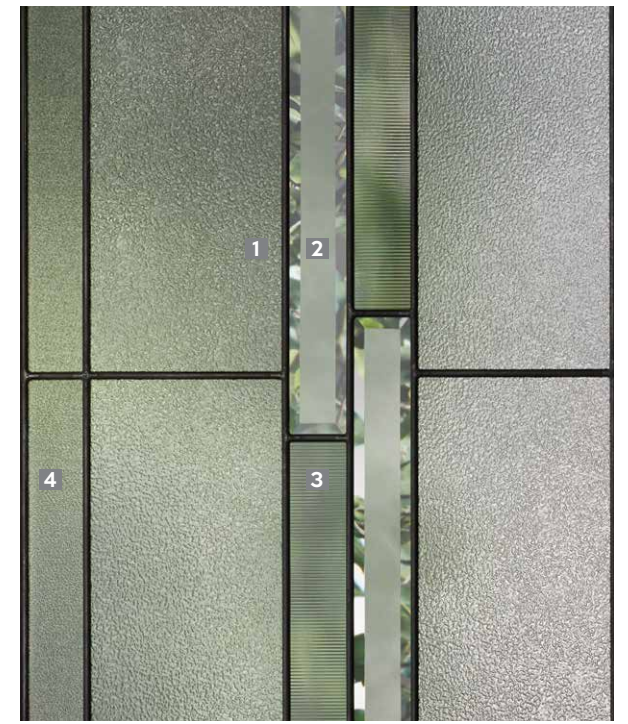

FINI STANDARD | STANDARD FINISH
NOTE: Autres finis disponibles | Other available finishes

 N Plomb soudé antique
Antique Welded Lead



23" X 49" \$
WHI104E+N



9" X 49" \$
WHI105E+N



23" X 65" \$\$
WHI108E+N



8" X 65" \$
WHI107E+N



NOTE: IMPOSTES ET LATÉRAUX DISPONIBLES | TRANSOMS AND SIDELITES AVAILABLE

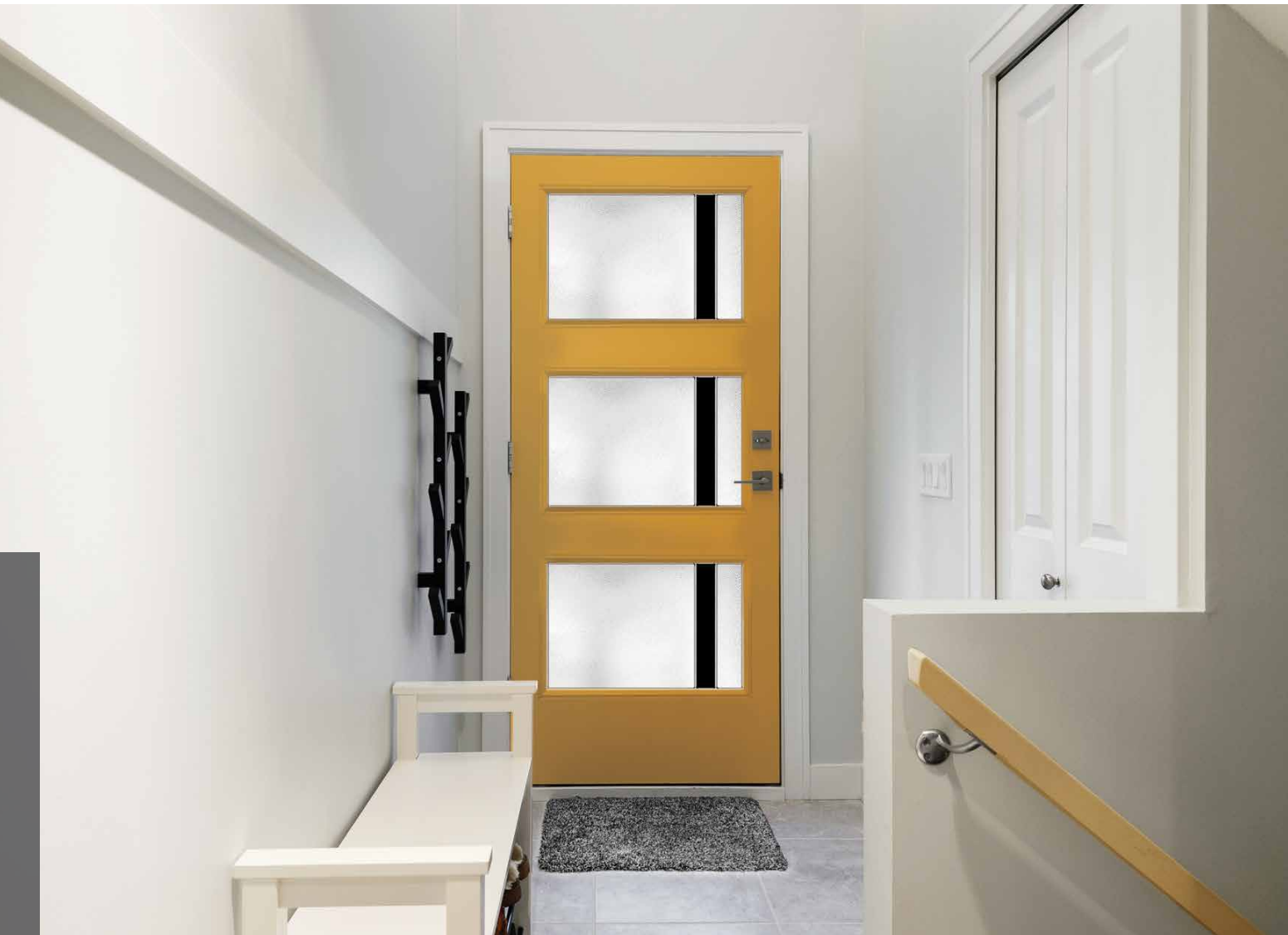

- 1 Martelé
Hammered
- 2 Noir Opaque
Opaque black
- 3 Kasumi



23" X 18" \$ ALT090E+PL (1X)
23" X 18" \$\$ ALT090E+PL (3X)

FINI STANDARD | STANDARD FINISH

NOTE: Autres finis disponibles | Other available finishes

PL Plomb soudé | Welded Lead



23" X 49" \$ AZU104E+N
9" X 49" AZU105E+N

FINI STANDARD | STANDARD FINISH

NOTE: Autres finis disponibles | Other available finishes

N Plomb soudé antique | Antique Welded Lead

- Kasumi 1
- Clair biseauté
Beveled Clear 2
- Grain 3

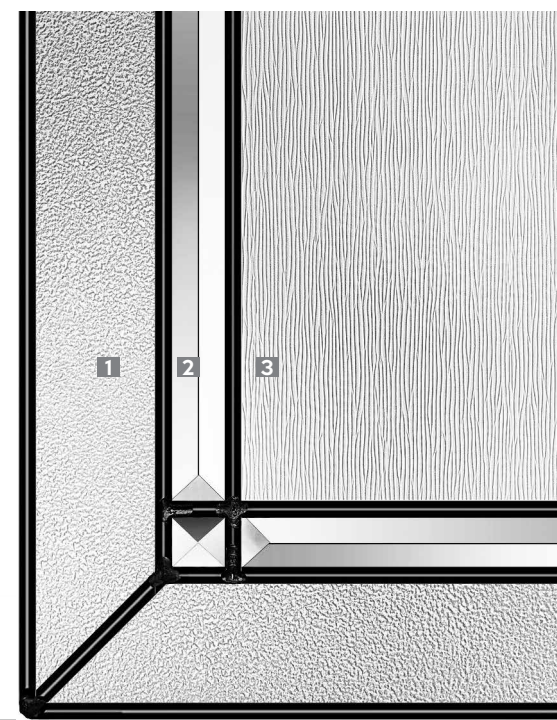



- 1 Screen Biseauté
Beveled Screen
- 2 Tige 1"
Caming 1"



23" X 65" \$\$ 8" X 65"
 QUA108NSE+CB QUA107NSE+CB

FINI STANDARD | STANDARD FINISH
 NOTE: Autres finis disponibles | Other available finishes



23" X 49" \$ 9" X 49"
 ROD104E+PL ROD105E+PL

FINI STANDARD | STANDARD FINISH
 NOTE: Autres finis disponibles | Other available finishes
 PL Plomb soudé | Welded Lead

- 1 Givré biseauté
Beveled Glue Chip
- 2 Screen
- 3 Martelé
Hammered

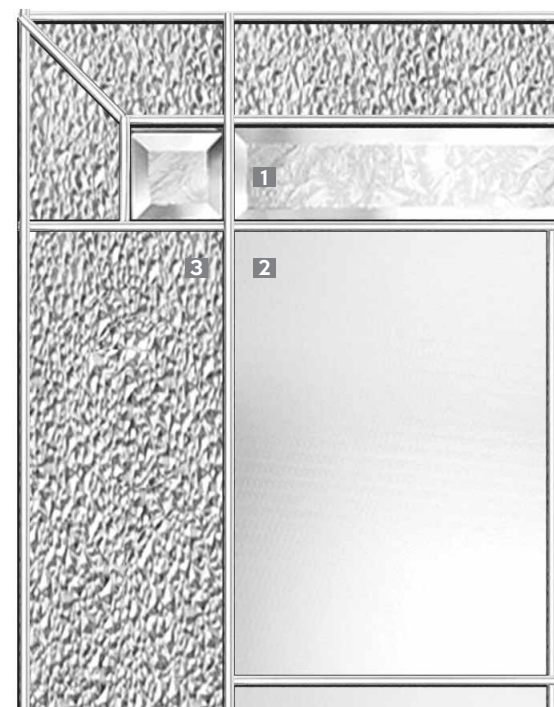

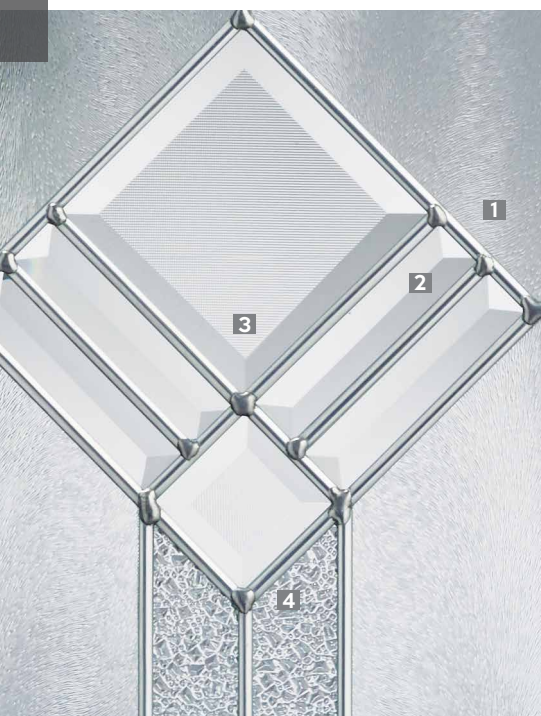
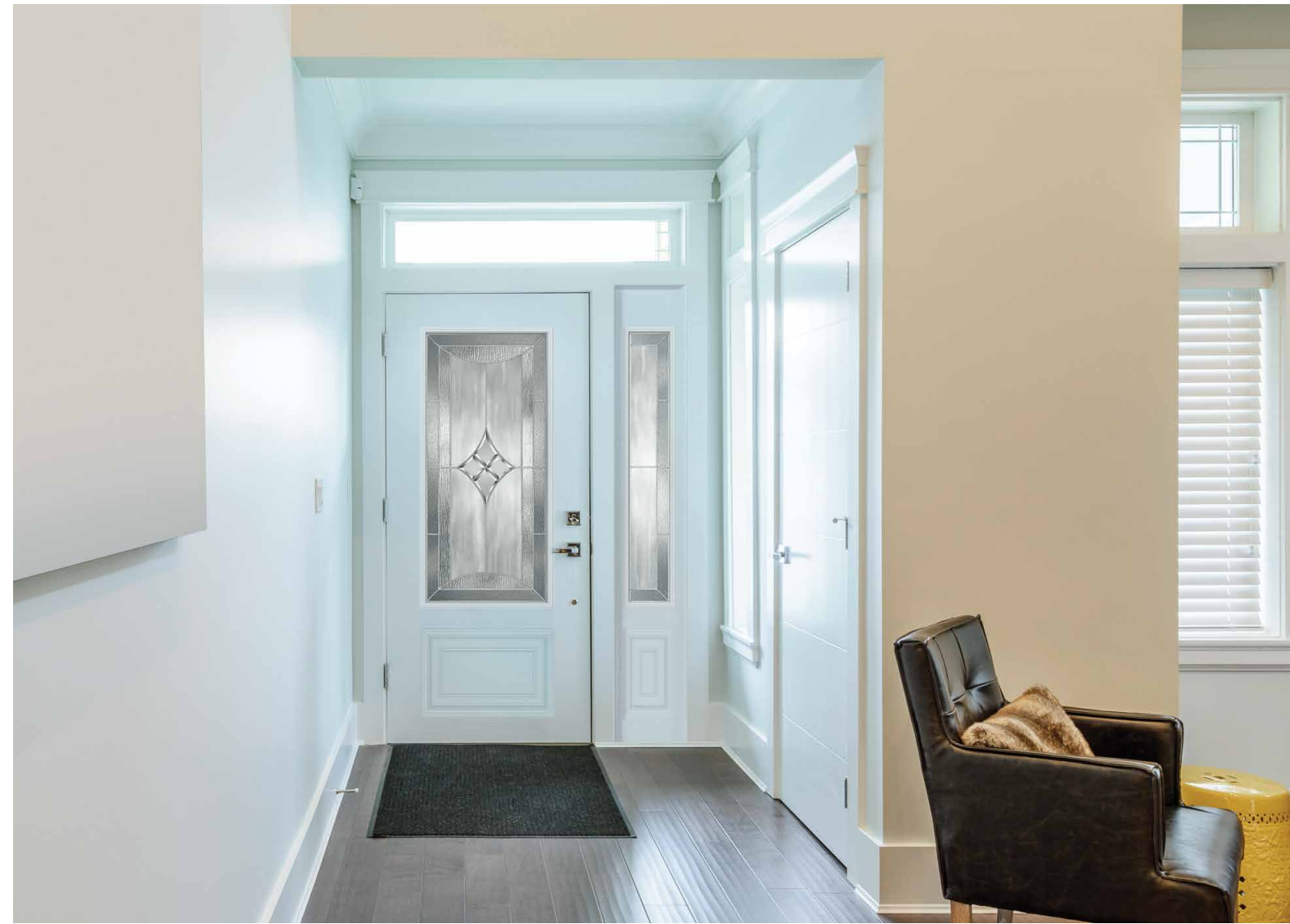

- 1 Chinchilla
- 2 Clair biseauté
Beveled Clear
- 3 Screen biseauté
Beveled Screen
- 4 Martelé
Hammered



23" X 49" \$ \$ 9" X 49"
PIX104E+PL PIX105E+PL

FINI STANDARD | STANDARD FINISH

NOTE: Autres finis disponibles | Other available finishes

PL Plomb soudé | Welded Lead



23" X 49" \$ 9" X 49"
MIA104E+PL MIA105E+PL

FINI STANDARD | STANDARD FINISH

NOTE: Autres finis disponibles | Other available finishes

PL Plomb soudé | Welded Lead

- Martelé
Hammered 1
- Niagara 2
- Chinchilla 3
- Screen biseauté
Beveled Screen 4

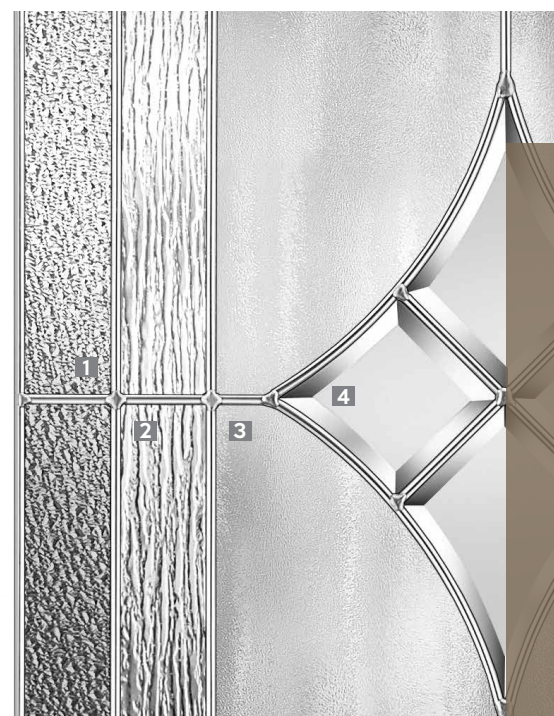



1 Acryverre Bevel Pane



23" X 49" \$\$\$ TUS104E+
 9" X 49" TUS105E+
 23" X 65" \$\$\$\$ TUS108E+
 8" X 65" TUS107E+

Disponible dans les grandeurs indiquées seulement.
 Only available in the sizes shown.



23" X 49" \$\$\$ INF104E+
 9" X 49" INF105E+

Disponible dans les grandeurs indiquées seulement.
 Only available in the sizes shown.

Acryverre Bevel Pane 1

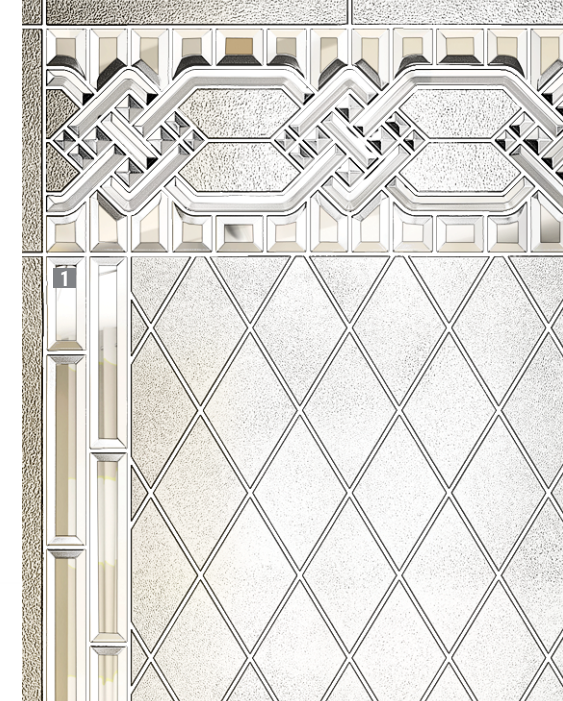



- Screen biseauté 1
Beveled Screen
- Kasumi 2
- Niagara 3
- Martelé 4
Hammered

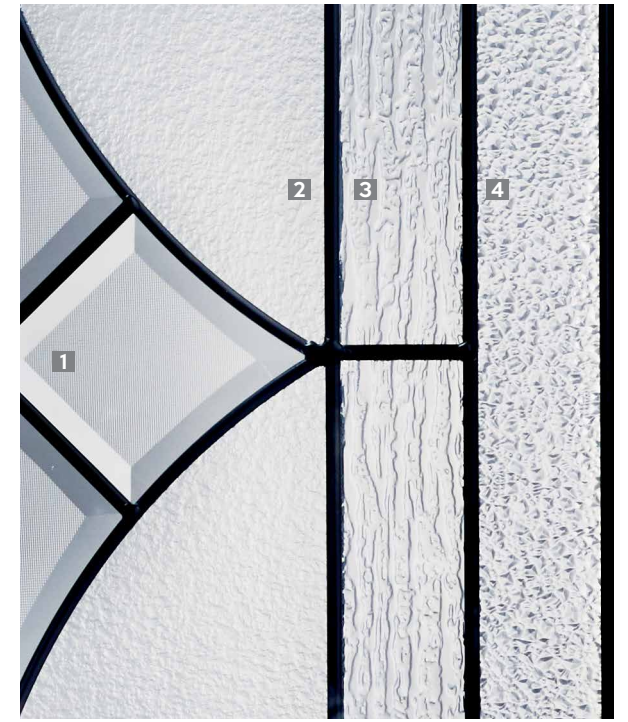

FINI STANDARD | STANDARD FINISH
 NOTE: Autres finis disponibles | Other available finishes
 N Plomb soudé antique
Antique Welded Lead



23" X 49" \$\$
 REN104E+N

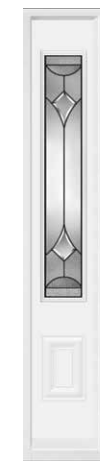

9" X 49" \$
 REN105E+N



23" X 65" \$\$\$
 REN108E+N



8" X 65" \$
 REN107E+N



NOTE: IMPOSTES ET LATÉRAUX DISPONIBLES | TRANSOMS AND SIDELITES AVAILABLE



Niagara 1

Givré biseauté 2
Beveled Glue Chip

Chinchilla 3

Granite 4
Granit

Losange clair biseauté 5
gravé à la main
Beveled Clear Diamond
Shaped Hand-Engraved

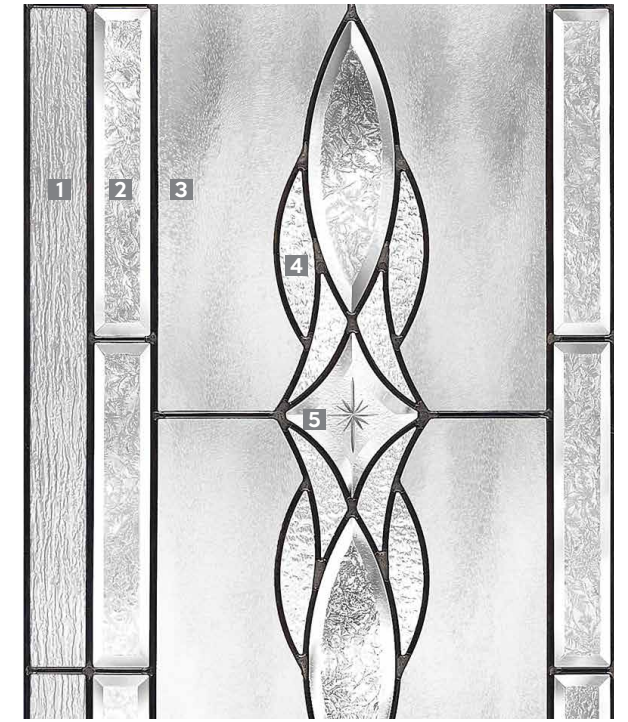

FINI STANDARD | STANDARD FINISH

NOTE: Autres finis disponibles | Other available finishes

N Plomb soudé antique
Antique Welded Lead



16" 1/2 X 40" 5/8

\$

VEN130E+N



23" X 49"

\$\$\$

VEN104E+N



9" X 49"

VEN105E+N



23" X 65"

\$\$\$\$

VEN108E+N

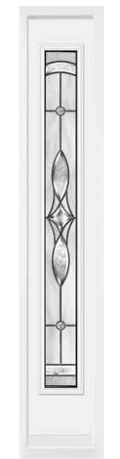

8" X 65"

VEN107E+N

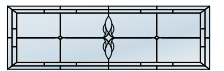

NOTE: IMPOSTES ET LATÉRAUX DISPONIBLES | TRANSOMS AND SIDELITES AVAILABLE



Verre Thermoformé **1**
Cast Glass

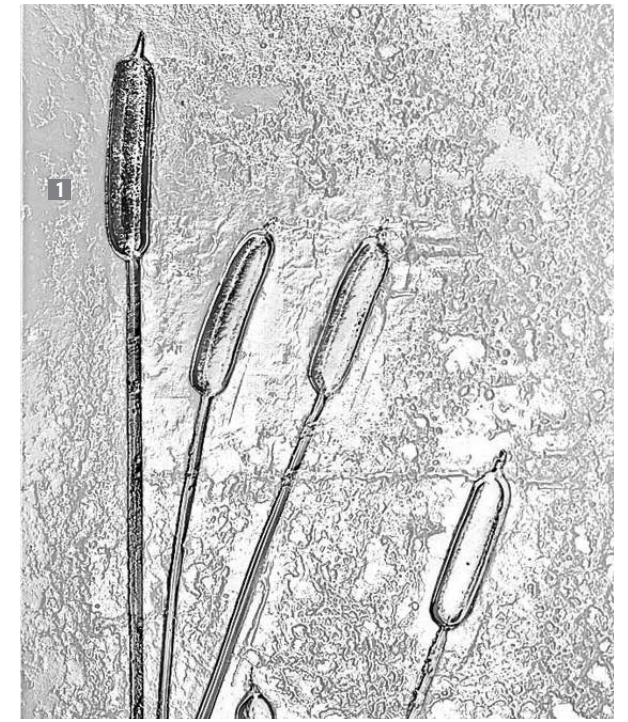

INTIMITÉ | INTIMACY

VERRE THERMOFORMÉ | CAST GLASS



23" X 49" \$\$
QUE104E+



9" X 49" \$
QUE105E+



21" X 65" \$\$\$
QUE106E+



23" X 65" \$\$\$
QUE108E+



8" X 65" \$
QUE107E+

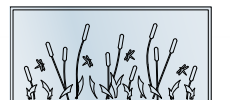
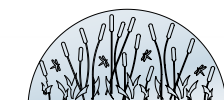

NOTE: IMPOSTES ET LATÉRAUX DISPONIBLES | TRANSOMS AND SIDELITES AVAILABLE



9 KARO111E+-V

SUR MESURE | CUSTOM

Personnalisez votre porte d'entrée avec un vitrail en latéral tout en gardant votre intimité, vous aurez aussi le loisir de profiter de la lumière naturelle extérieure.

Customize your front door with stained glass in a sidelite while protecting your privacy. Let the natural light in!

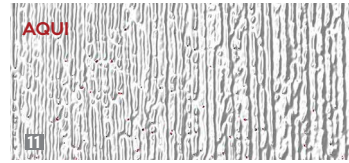
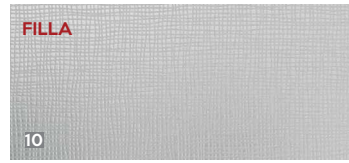
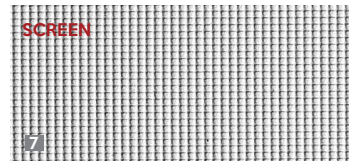
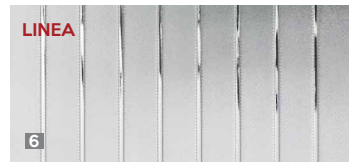
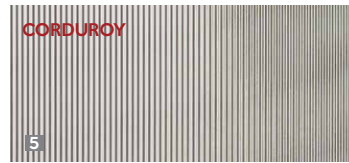
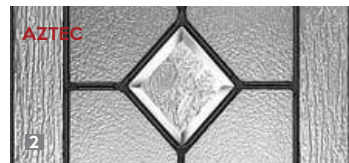
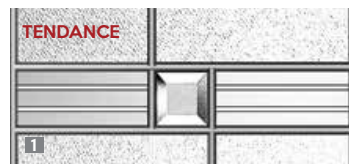

1 TEN111NSE+-PT

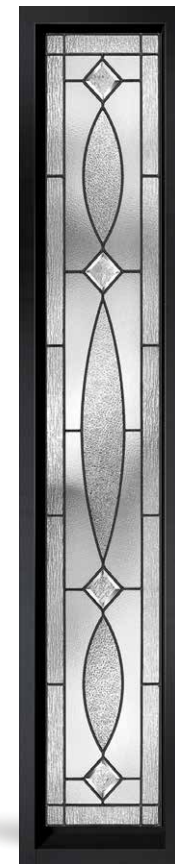

2 AZT111E+-N



3 TRE111NSE+-PT



4 CHIN111E+-PL



5 COR111E+-V



6 LIN111E+-V



7 SCR111E+



8 KAR111E+-V



10 FIL111E+



11 AQU111E+-V



12 SAT111E+



13 CBG111E+*



LES STORES BLINK

- Version améliorée
- 6 couleurs disponibles
- Largeur disponible 14 à 80 po
- Hauteur disponible 13 à 80 po

*Un ou deux opérateurs selon la dimension du produit fini

BLINK BLINDS

- Enhanced version
- 6 colors available
- Available Width from 14 to 80 in
- Available Height from 13 to 80 in

*One or two operators depending on the size of the finished product



Fermé | Closed



Ouvert | Open

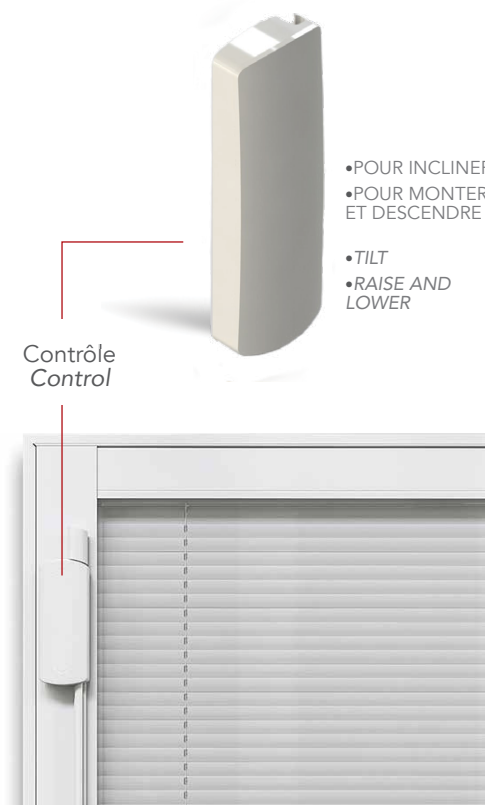

Contrôle Control

- POUR INCLINER
- POUR MONTER ET DESCENDRE
- TILT
- RAISE AND LOWER

OPTIONS DE COULEURS | COLOR OPTIONS:



NOTE: La construction et les contrôles des stores sur mesure diffèrent légèrement de nos stores standards illustrés à la page 63.

NOTE: Construction and controls of custom blinds are slightly different from our standard blinds shown on page 63.



DIMENSIONS DISPONIBLES | AVAILABLE SIZES:

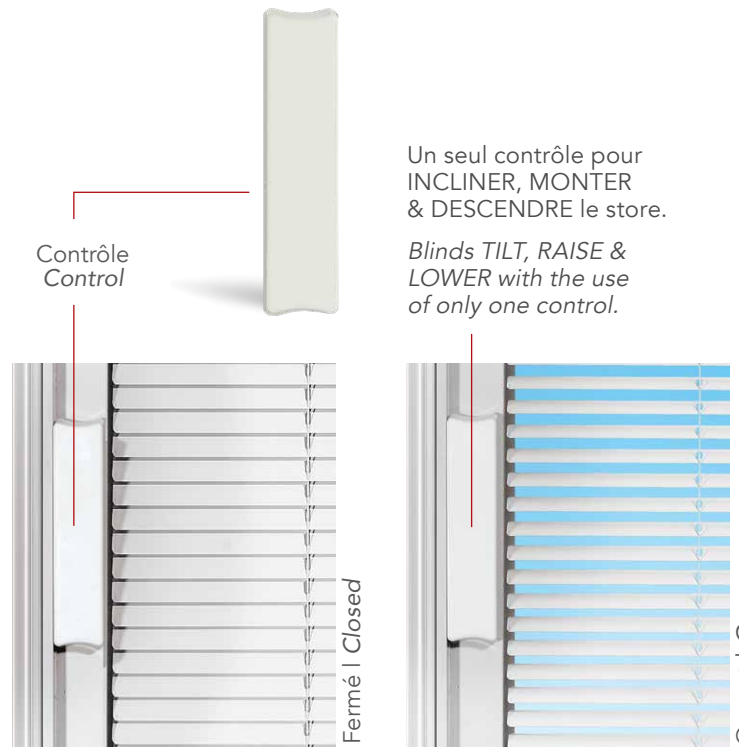
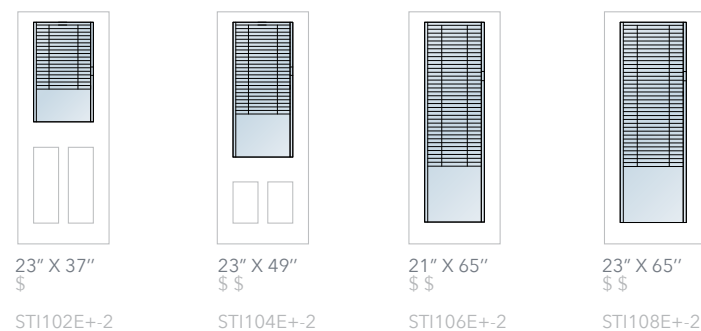

Contrôle Control

Un seul contrôle pour INCLINER, MONTER & DESCENDRE le store.

Blinds TILT, RAISE & LOWER with the use of only one control.

Fermé | Closed

Ouvert | Open

COULEUR DISPONIBLE | AVAILABLE COLOR:



NOTE: Disponible dans les grandeurs indiquées seulement.

NOTE: Only available in the sizes shown.

MOULURE DYNASTIE
DYNASTIE MOLDING



- Les moulures Dynastie s'harmonisent parfaitement avec nos cadres Exécutifs en PVC et aluminium.
- Les moulures Dynastie n'affectent en rien la structure du panneau de porte puisqu'elles ne requièrent pas le perçage de la porte.
- Stylish SURFACE-MOUNTED moldings that match our glass frame and Executive panel designs.
- Dynastie Moldings do not affect the structure or performance ratings of the door because they are face-mounted.

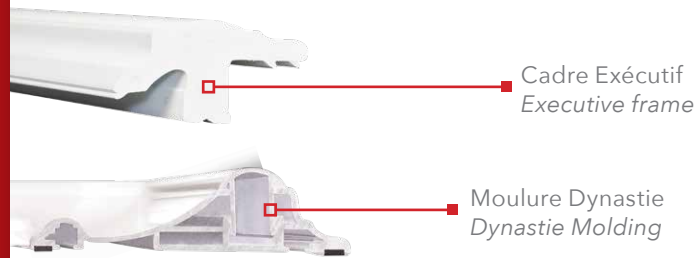

Plusieurs dimensions disponibles.
Various sizes available.

PANNEAU EXÉCUTIF
EXECUTIVE PANEL



Panneaux décoratifs haute définition, assurez-vous d'obtenir le produit original.

Ces panneaux «haute définition» qui évoquent les panneaux ravalés à moulures rapportées des portes de bois traditionnelles, peuvent être combinés avec des panneaux de verre décoratif, pour une multitude de possibilités et d'agencements.

High-definition decorative panel, make sure you buy the original.

These "high definition" panels, inspired by the moldings used on traditional wooden doors, can be used with decorative glass panels, in any number of combinations.

CADRE EXÉCUTIF
EXECUTIVE FRAME



ALUMINIUM: CEXExxx-AL



PVC: CEXExxx-BL

CADRE URBAIN
URBAN FRAME

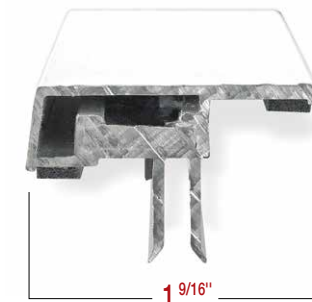
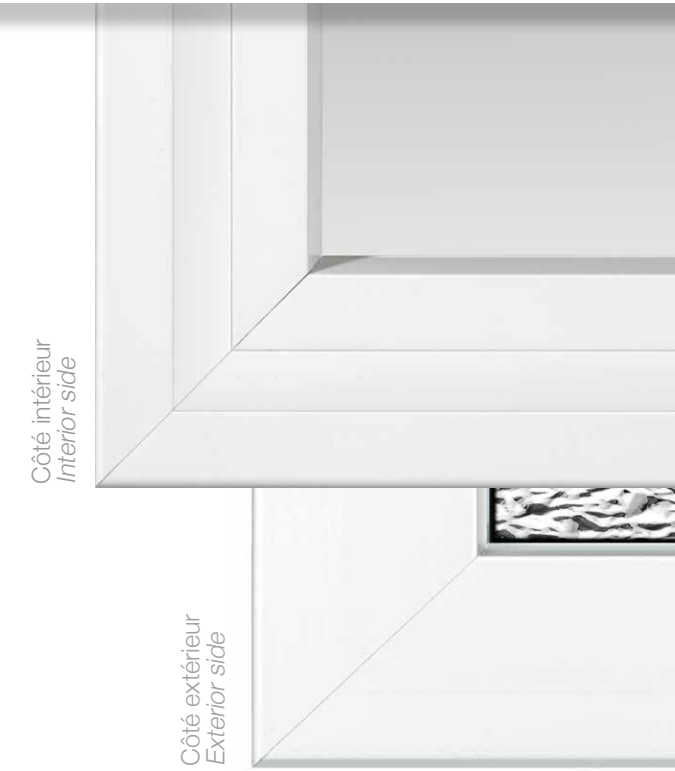

ALUMINIUM: CURBxxx-UB ou UA



PVC: CURBxxx-UPVC

CONFIGURATIONS LES PLUS POPULAIRES | THE MOST POPULAR LAYOUTS :



23" X 21" 3/4
23" X 9" 1/2
23" X 21" 3/4

23" X 18" (3X)

23" X 9" 1/2
23" X 37"
23" X 9" 1/2

23" X 49"
23" X 12"

23" X 65"



ÉTAPES À SUIVRE: STEPS TO FOLLOW:

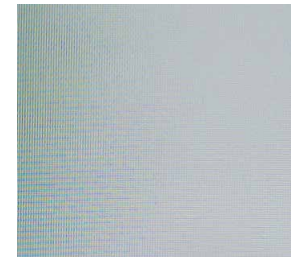

1- Verre | Glass

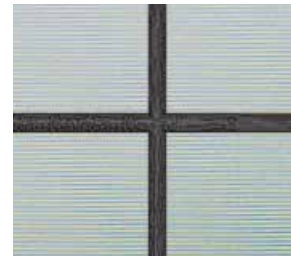

2- Tige | Caming

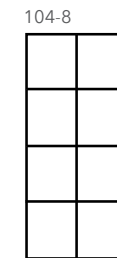

3- Configuration



4- Cadre | Frame



CRÉEZ VOTRE PROPRE PORTE!

En effet Verre Select vous offre la possibilité de créer votre propre porte.

4 étapes simples: choisissez votre verre, choisissez votre tige, déterminez la configuration et le cadre qui vous plait le plus... le tour est joué...

Notez que certaines restrictions s'appliquent, parlez-en à votre spécialiste de portes et fenêtres!

CREATE YOUR OWN DOOR!

At Verre Select, we give you the ability to create your own personal front entrance design!

Just 4 easy steps: choose from multiple options of types of glass, choose your caming option, choose your configuration and the frame.

The end result is thousands of available custom looks, that YOU created!

Pour plus d'information
www.verreselect.com

For more information
www.verreselect.com



**Votre
Création!**

**Your
Creation!**

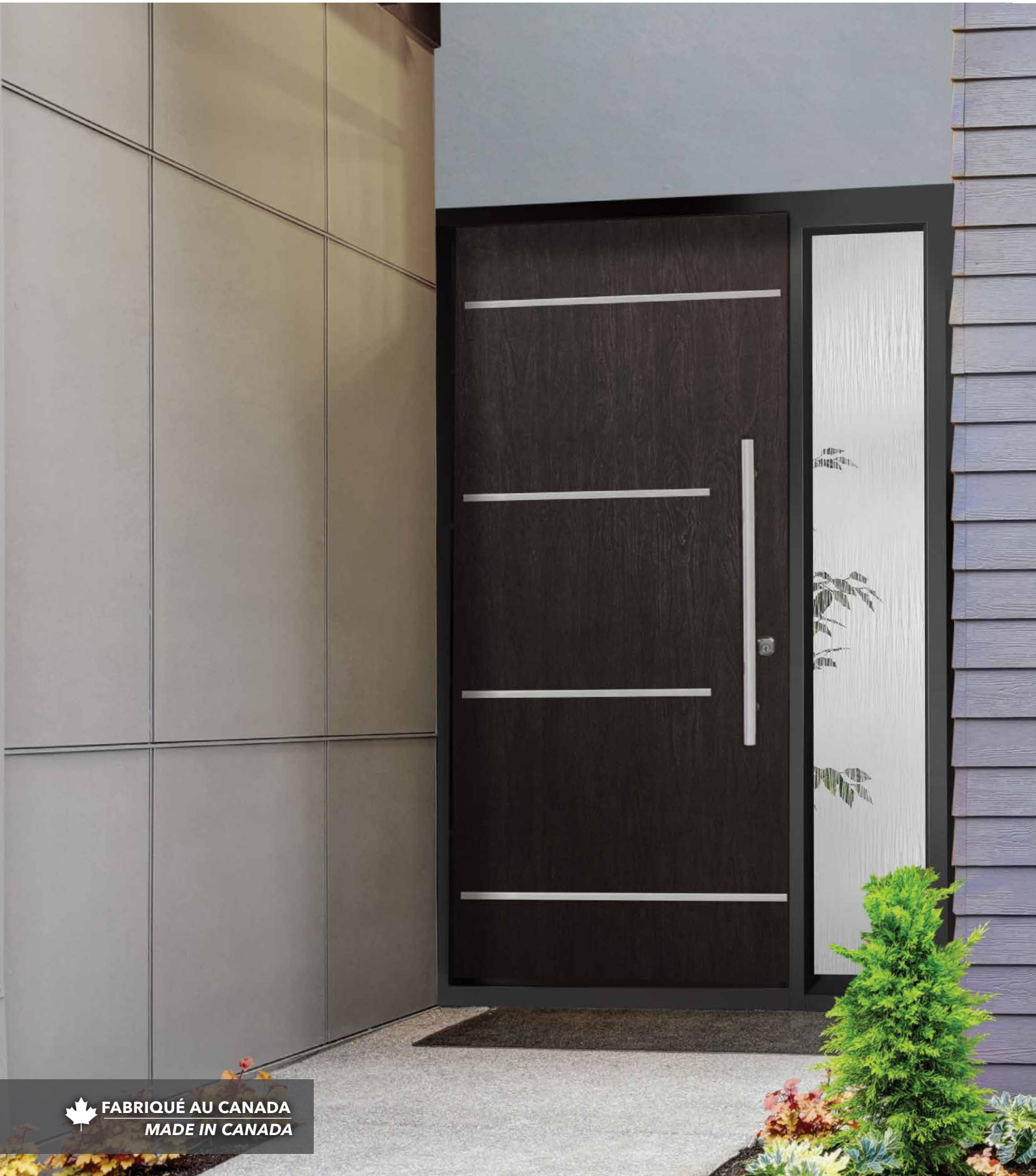

FABRIQUÉ AU CANADA
MADE IN CANADA

CONTEMPORAINE | CONTEMPORARY

- Construction ultra-robuste
- Grain de bois Cerisier
- Technologie brevetée
- Adaptée à notre climat
- Dimensions disponibles en inventaire: 34" et 36" X 79"

- Superior construction
- Cherry wood grain
- Patented technology
- Adapted to our weather
- Dimensions available in inventory: : 34" et 36" X 79"

Pour plus d'information www.verreselect.com
For more information www.verreselect.com



100



101



304B



SERRURE MULTIPOINT DISPONIBLE MULTIPOINT LOCK AVAILABLE





FABRIQUÉ AU CANADA
MADE IN CANADA

TRADITIONNELLE | TRADITIONAL

CERISIER | CHERRY



NOV-CC-34-2PR
NOV-CC-36-2PR



NOV-CC-34-2P
NOV-CC-36-2P

Le SEUL cadre en FIBRE DE VERRE sur le marché!
The ONLY FIBERGLASS FRAME on the market!

CERISIER
CHERRY



CHÊNE | OAK



NOV-CO-34-2P
NOV-CO-36-2P



NOV-CO-34-6P
NOV-CO-36-6P

CHÊNE
OAK



*Plusieurs couleurs disponibles, informez-vous auprès de votre spécialiste de porte. | Several colors available, ask your door specialist.

CONFIGURATIONS DE VERRES DISPONIBLES | AVAILABLE GLASS CONFIGURATIONS

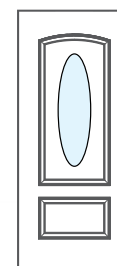

120
Thermo
13^{7/8}" x 37"

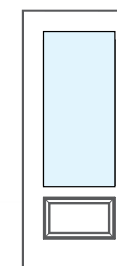

104
Thermo
22" x 48"



108
Thermo
22" x 64"

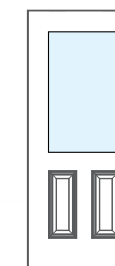

102
Thermo
22" x 36"



096C
Thermo
22" x 11"

SERRURE MULTIPOINT DISPONIBLE | MULTIPOINT LOCK AVAILABLE





LIN111E+V

CLI-NO-34-2P-D

3 CHOIX DE COULEURS | 3 COLOR CHOICES



Blanc | White

Intérieur | Interior
CLI-BL-34-2P
CLI-BL-36-2P



Noir | Black

Intérieur | Interior
CLI-NO-34-2P
CLI-NO-36-2P



Brun | Brown

Intérieur | Interior
CLI-BR-34-2P
CLI-BR-36-2P

AVANTAGES | BENEFITS

- Résistance accrue aux égratignures
- Porte en fibre de verre colorée dans la masse
- Résistance accrue aux rayons UV
- Isolant à l'uréthane sans CFC
- Résistance accrue aux chocs
- Un produit de qualité simplement plus durable
- Scratch resistant
- The only fiberglass door that has a pre-pigmented fiberglass skin.
- High performance UV stable finish is also heat reflective and resists fading.
- CFC free polyurethane foam filled core.
- Almost 100% dent free
- Simply a better and longer lasting, pre-finished, high quality door product.

CONSTRUCTION DE LA PORTE | DOOR CONSTRUCTION



GRANDEURS DE VITRAIL | GLASS SIZES

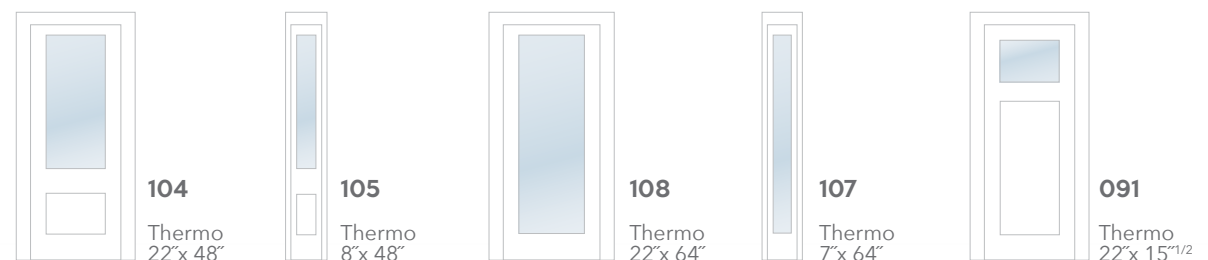

SERRURE MULTIPOINT DISPONIBLE | MULTIPPOINT LOCK AVAILABLE





LA DIFFÉRENCE EST
DANS LES **DETAILS!**

THE DIFFERENCE IS
IN THE **DETAILS!**

 **FABRIQUÉ AU CANADA**
MADE IN CANADA

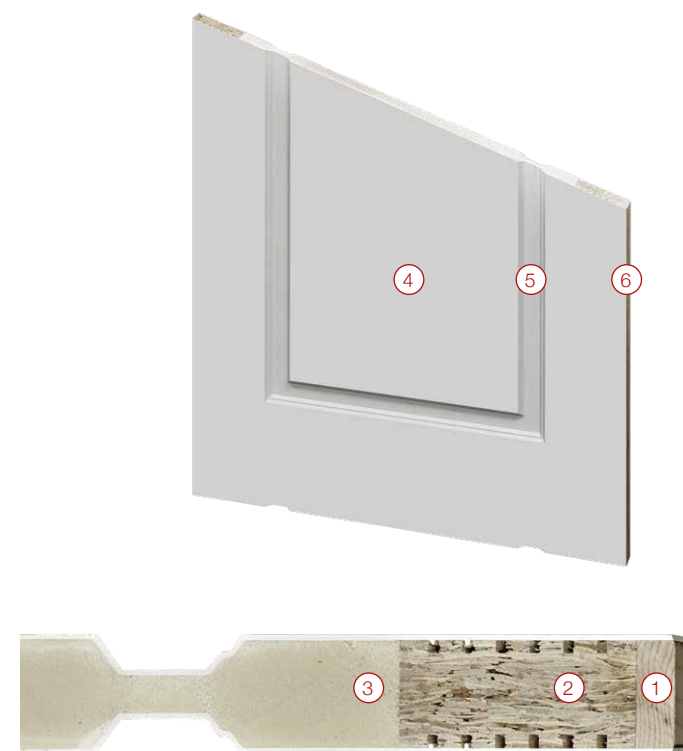

- ① Finition en bois dur de 5/8"
- ② Battant en LVL de 4" 1/8 des deux côtés
- ③ Mousse polyuréthane sans CFC haute densité
- ④ Feuille de fibre de .100"
- ⑤ Moulage haute définition
- ⑥ Champ de la porte carré très contemporain

Doit être peinturé à votre choix de couleur pour un agencement parfait à votre demeure.



Option avec
fenêtre de porte
disponible.

Option with
door window
available.



EDG-3479-2P
AMA104E+-PL

- ① 5/8" Solid Hard Wood Cap
- ② 4" 1/8 LVL on both sides
- ③ High density CFC-free polyurethane injected foam
- ④ .100" Thick Skin
- ⑤ High precision mounting with better defined modern lines
- ⑥ Very contemporary square edge

Must be painted at your color choice for a perfect fit to your home.

MODÈLES DISPONIBLES | AVAILABLE MODELS

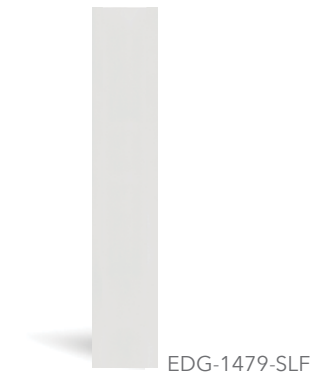



Visualisez votre
nouvelle porte avant
même son achat.

*Visualize your new
door before buying it.*

1 Photographiez votre
maison.
*Take a picture of your
house.*

2 Créez votre porte.
Create your door.

3 Visualisez-la sur
votre maison.
View it on your house.

DISPONIBLE MAI 2019
AVAILABLE MAY 2019

WWW.VERRESELECT.COM